

INSTALLATION GUIDE:

LED DOWNLIGHT
990.0212.01



IMPORTANT:





The luminaire must not be covered with any thermally insulating material.

This product contains a light source of **energy class D**. Please refer to relevant product technical data sheet for further information.

The LED module in this luminaire is not replaceable. When the light source reaches its end of life, the whole luminaire must be replaced.

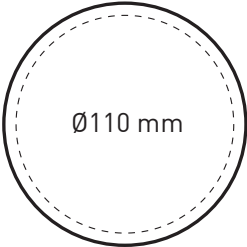
PLEASE RETAIN THIS GUIDE FOR FUTURE REFERENCE AND RECYCLE PACKAGING

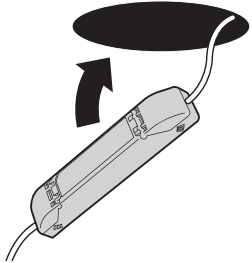
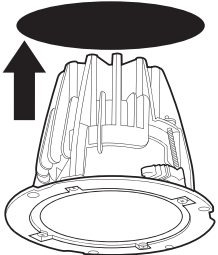
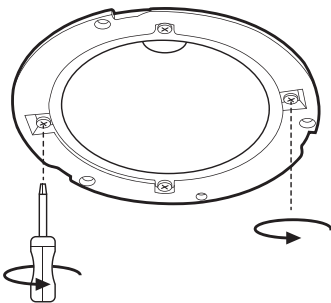
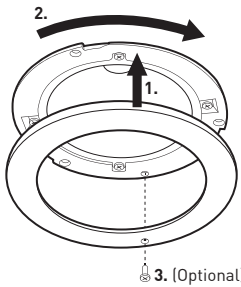

<p>A  ISOLATE MAINS SUPPLY BEFORE COMMENCING INSTALLATION</p>  <ul style="list-style-type: none">- Cut a 110 mm circular hole at desired location	<p>B</p>  <ul style="list-style-type: none">— BLUE— YELLOW / GREEN (if present)— BROWN - SWITCHED— BLACK - UNSWITCHED (Permanent) Emergency only <ul style="list-style-type: none">- Connect luminaire to mains supply using a terminal block (not supplied) compliant with requirements of EN60998-2-1 or 2-2.- For Touch & Dim or DALI wiring, see installation guide 990.0009.01.
<p>C</p>  <ul style="list-style-type: none">- Install driver into ceiling void.	<p>D</p>  <ul style="list-style-type: none">- Insert luminaire into cut-out, ensuring 50mm minimum air space around heatsink & driver. Luminaire must not be covered with any debris or insulating material.
<p>E</p>  <ul style="list-style-type: none">- Turn two fitting screws clockwise to secure luminaire into ceiling. DO NOT USE POWER TOOLS.	<p>F</p>  <ul style="list-style-type: none">- Install twist and lock bezel complete with any accessories.- Optional anti-tamper bezel - Install twist & lock bezel, ensuring screw holes are aligned, and fit security screw. <p> REINSTATE MAINS SUPPLY</p>

INSTALLATION GUIDE:

LED DOWNLIGHT
990.0247.01

IMPORTANT:

The luminaire must not be covered by any debris or heat insulating material. Electrical termination must be carried out by a qualified electrician in accordance with the latest edition of IEE wiring regulations BS 7671. Photobiological safety is not assured if the LED module is lit up without the cover. Direct exposure to blue LED light is dangerous for the eyes.

PLEASE RETAIN THIS GUIDE FOR FUTURE REFERENCE AND RECYCLE PACKAGING.



A



ISOLATE MAINS SUPPLY BEFORE COMMENCING INSTALLATION

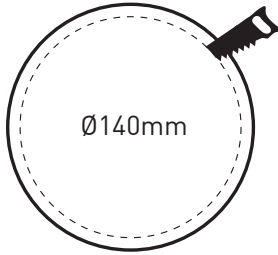

- Cut a Ø140mm circular hole at the desired location using a holesaw.

B

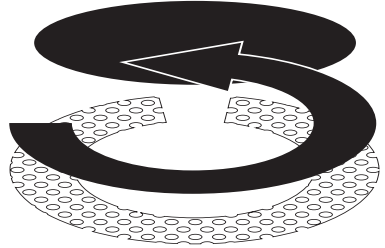

- Feed the mesh up into ceiling void.

C

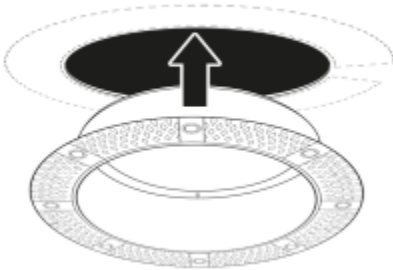

- Fit the plaster-in collar into the hole.

D

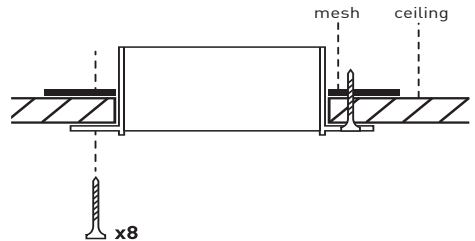

- Use a hand to hold the mesh down whilst fixing the collar in place with drywall screws. All eight screws must be used to avoid risk of the plaster cracking.

TAKE CARE TO AVOID FINGERS WHEN FIXING THE SCREWS

E

- 1 Plaster the ceiling upto the edge of the collar. When dry and painted, offer the fitting up to the collar.
 - 2 Use the three pips in the collar to correctly position the fitting.
- Please refer to the product specific installation guide for detailed information on installing the luminaire.

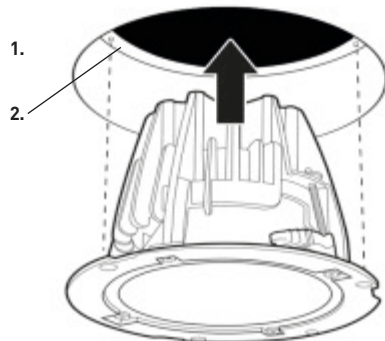

INSTALLATION GUIDE:

130 mm IP65 BEZEL
990.0301.01



IMPORTANT:

The luminaire must not be covered by any debris or insulating material. Ensure there is a minimum of 50 mm airspace around the luminaire and control gear. Electrical termination must be carried out by a qualified electrician in accordance with the latest edition of IEE wiring regulations BS7671.

PLEASE RETAIN THIS GUIDE FOR FUTURE REFERENCE AND RECYCLE PACKAGING.

A ISOLATE MAINS SUPPLY BEFORE COMMENCING INSTALLATION

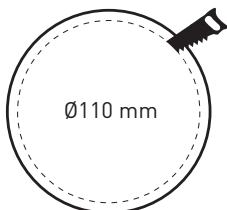

- Cut a 110 mm circular hole at the desired location using a hole saw.

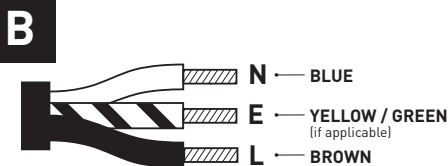

- Connect the luminaire to the mains supply using a terminal block (not supplied) compliant with the requirements of EN60998-2-1 or 2-2.
- Install the driver into the ceiling void, ensuring it is not covered by any debris or insulating material.

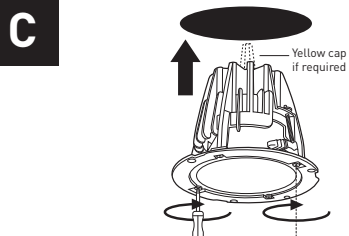

- Offer the luminaire into the ceiling void without using the rubber gasket. If there is a risk of the heatsink being covered, please insert a yellow cap into the top of the luminaire.
- Turn the 2 fixing screws clockwise to secure, leaving a 5 mm gap off the ceiling. **DO NOT USE POWER TOOLS.**

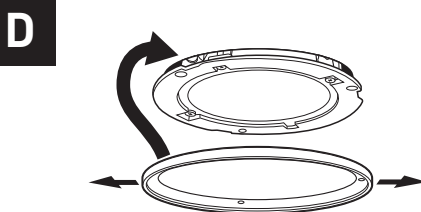

- Stretch the rubber gasket over and behind the lip of the luminaire, ensuring the gasket lip is facing downwards and that the 3 holes in the gasket are aligned to the 3 holes on the luminaire as shown.

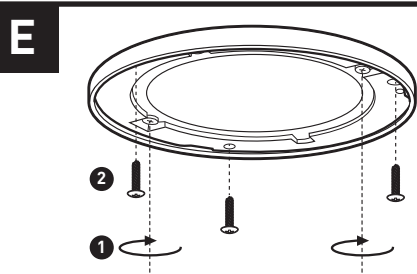

- Re-tighten the 2 fixing screws (1) until luminaire is secure. Please ensure these screws are set to a torque setting of between 0.4 - 0.5 Nm.
- Using the screws supplied (2), screw the gasket to the luminaire via the 3 aligned holes until secure to ceiling.

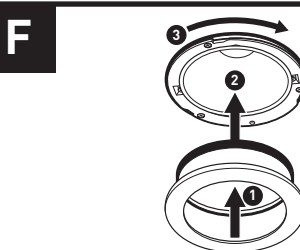

- Remove film from both sides of polycarbonate lens and locate with rubber seal behind the twist and lock bezel (1).
- Install the twist and lock bezel, ensuring the rubber gasket lip is not trapped and is around the bezel (2,3).



REINSTATE MAINS SUPPLY