

34 Series Datasheet

LUMENLOOP

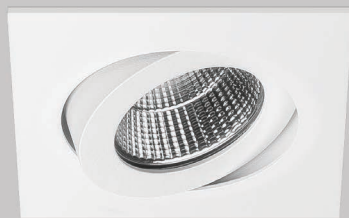

ø80 mm

Key Features

- ▶ Professional, minimal LED Downlight
- ▶ Die-cast low profile bezel, white RAL9003
- ▶ Life >50,000 hours L70/F50
- ▶ Injection moulded 36° faceted reflector
- ▶ High Efficacy, low glare
- ▶ No visible flicker (IEEE PAR1789 2015)
- ▶ Dimming, DALI and emergency options
- ▶ 5 year warranty

Technical Drawing

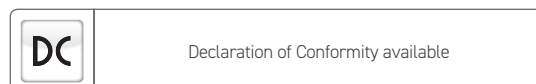
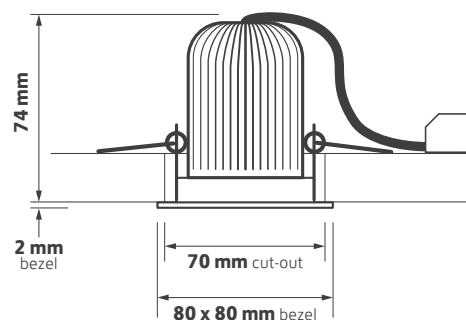

Ordering Information

Output lm	Power tcW	Colour	Model Ref.
750	8	830	34.001
775	8	840	34.002

Options

Please select from the options below.

Phase-cut mains dimming	/MDIM
SwitchDIM, DALI or DSI	/ECO
Casambi wireless network (inc dim)	/BTC
3 hour emergency conversion	/EM
3 hour self-test and DALI emergency conversion	/EMD

Options

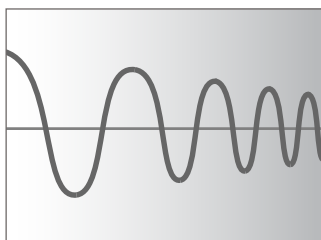

/MDIM
Phase-cut mains dimming

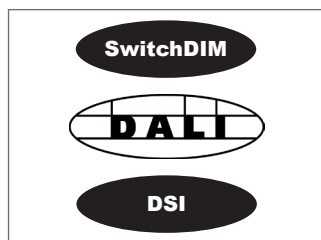

/ECO
SwitchDIM, DALI or DSI

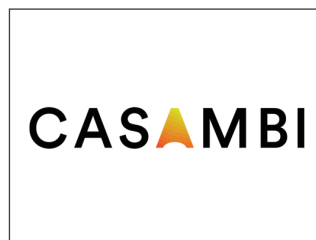

/BTC
Casambi wireless network
(inc dim)



/EM
3 hour emergency conversion



/EMD
3 hour self-test and DALI emergency
conversion

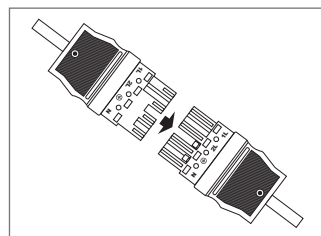

Product variations
Plug and Sockets

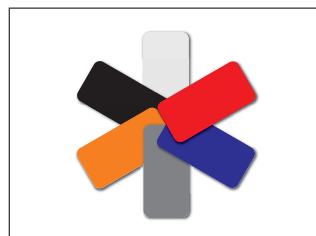

Product variations
Any RAL colour