

INSTALLATION GUIDE:

RECESSED LINEAR 990.0382.01



NOTE: THE LED MODULES IN THIS LUMINAIRE ARE NON-USER REPLACEABLE.
PLEASE RETAIN THIS GUIDE FOR FUTURE REFERENCE AND RECYCLE PACKAGING.

A ISOLATE MAINS SUPPLY BEFORE COMMENCING INSTALLATION

IMPORTANT: DO NOT USE POWER TOOLS TO TIGHTEN FIXINGS ON THIS PRODUCT.

Cut Out Sizes

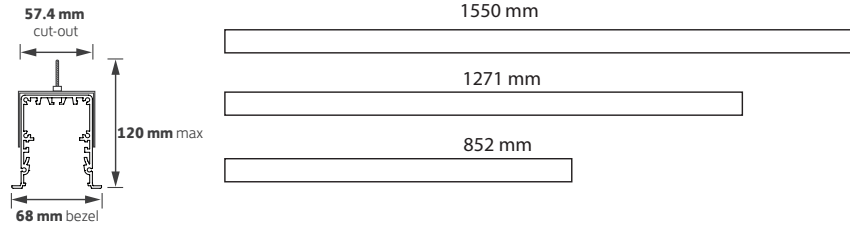

- Cut a rectangular hole in the ceiling based on length of fitting.

- ## B
- Prise out the diffuser using a plastic lever tool (not supplied) or card, starting in the **centre of the diffuser** and working outwards.

- Please note: Do not use metal tools such as screwdrivers to do this as they may damage the diffuser / body

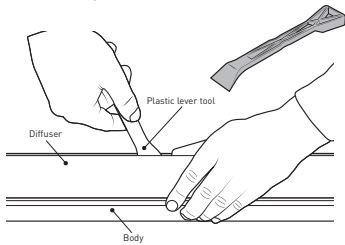

- ## C
- Using a terminal driver, ease out the LED tray retaining clips, whilst pulling the tray up, one side at a time, and remove the LED tray as shown.

- Slide tray to one end and remove

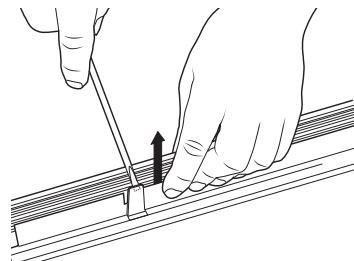

D

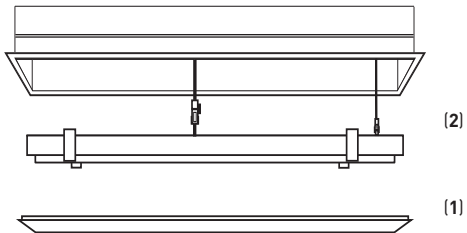

- Remove diffuser (1).
- Remove LED tray as shown (2).
- Unclip module plugs / earthing spade.

We reserve the right to amend any product specification without prior notice. Any alterations made to the luminaire may affect life and light output and invalidate any warranty. Luminaire complies with all safety standards set out in BS EN 60598.

IMPORTANT:

The luminaire must not be covered by any debris or insulating material. Ensure there is a minimum of 50 mm airspace around the luminaire. Electrical termination must be carried out by a qualified electrician in accordance with the latest edition of IEE wiring regulations BS7671.

E

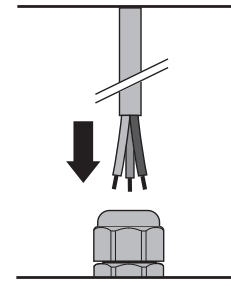

- Feed the mains cable through the cable gland

F

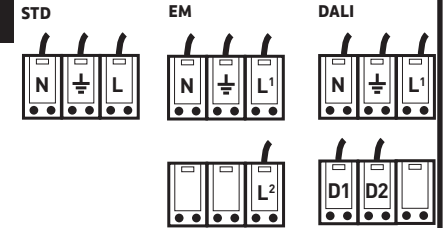

- Connect mains supply to terminal block.
- For switch dim link D2 to N, connect D1 to mains supply via a push to make retractive switch.
- Secure cable gland

G

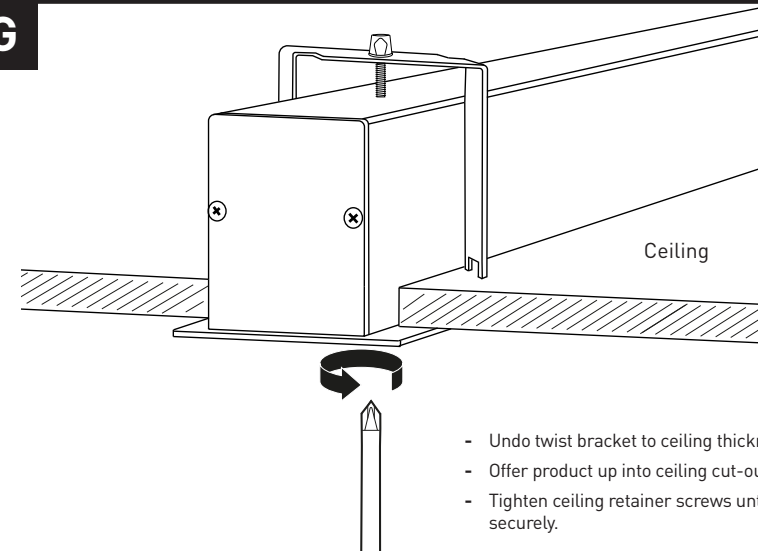

- Undo twist bracket to ceiling thickness +5 mm.
- Offer product up into ceiling cut-out.
- Tighten ceiling retainer screws until product is held securely.

H

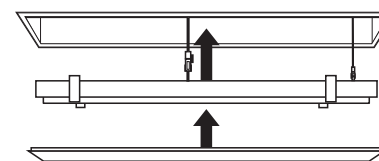

- Offer up LED tray(s) and re-connect plugs and earthing spade, then push LED tray into fitting ensuring clips are correctly located and secure.
- Push diffuser back into fitting until secure.



REINSTATE MAINS SUPPLY

We reserve the right to amend any product specification without prior notice. Any alterations made to the luminaire may affect life and light output and invalidate any warranty. Luminaire complies with all safety standards set out in BS EN 60598.