

# 12 Series

## Data Sheet



### KEY FEATURES

- Ultra low-glare, high performance LED linear
- Premium matt black dark-light baffles as standard
- Features 50° office LED lens as standard
- Tridonic LED and driver system inside
- RAL 9006 grey as standard with black or white options
- Surface mounted as standard with suspension option
- Available in 1.2m and 1.5m lengths
- Lumen maintenance L80/F10 @ >75,000 hours
- Proudly made in the UK

### DIMENSIONS

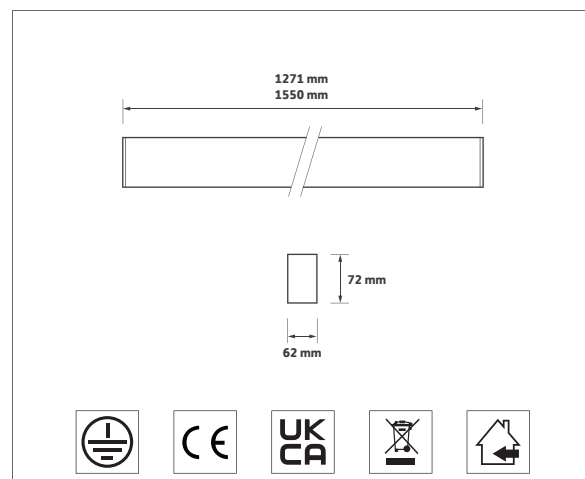

### ORDERING INFORMATION

Length (m)	Colour temp	Luminaire output (lm)	Luminaire power (tcW)	UGR	Luminaire efficacy (lm/tcW)	Model ref.
1.2	830	1850	14	12	132	<b>12.001/LO</b>
1.2	830	2725	20	13	136	<b>12.001</b>
1.2	830	3575	27	14	132	<b>12.001/HO</b>
1.2	840	1925	14	12	138	<b>12.002/LO</b>
1.2	840	2850	20	13	143	<b>12.002</b>
1.2	840	3750	27	14	139	<b>12.002/HO</b>
1.5	830	2300	17	12	135	<b>12.003/LO</b>
1.5	830	3425	25	13	137	<b>12.003</b>
1.5	830	4475	33	14	136	<b>12.003/HO</b>
1.5	840	2400	17	12	141	<b>12.004/LO</b>
1.5	840	3575	25	13	143	<b>12.004</b>
1.5	840	4675	33	14	142	<b>12.004/HO</b>

### OPTIONS

Options	Suffix
Low or high output	<b>/LO, /HO</b>
Body finish	<b>/WH, /BK</b>
White softlight baffles	<b>/WSB</b>
Wide beam lens 80°	<b>/WB</b>
Control gear	<b>/ECO, /BTC</b>
Emergency - Integral indicator	<b>/EMI, /EMSI, /EMDI</b>
Suspension kit	<b>SUS.163/2/2M</b>
Baffle removal tool	<b>PT001</b>
Product variations available	<b>PV.</b>

# 12 Series

## Options & accessories



**/WH**

White body  
RAL 9016



**/BK**

Black body  
RAL 9005



**/WSB**

White soft-light baffles

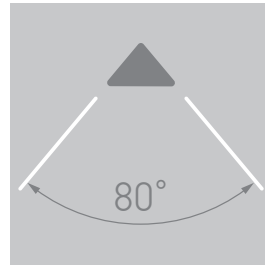

**/WB**

Wide beam 80° lenses

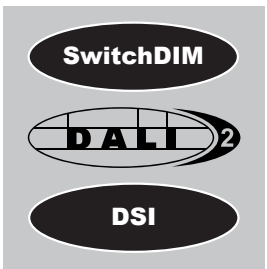

**/ECO**

SwitchDIM, DALI or DSI  
control gear



**/BTC**

Bluetooth control  
inc. dimming



**/EMI**

Emergency  
Integral indicator

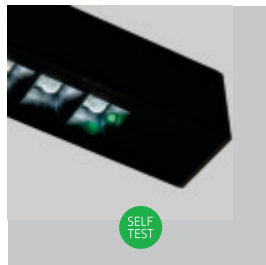

**/EMSI**

Self-test emergency  
Integral indicator



**/EMDI**

DALI emergency  
Integral indicator



**/ECO/EMDI**

DALI luminaire and  
DALI emergency



**BU.163/90**

Direct butt-up kit 90°



**BU.163/180**

Direct butt-up kit 180°



**SUS.163/2/2M**

Suspension kit



**PT001**

Baffle removal tool

# 12 Series

## Options & accessories



### PV - PRODUCT VARIATIONS

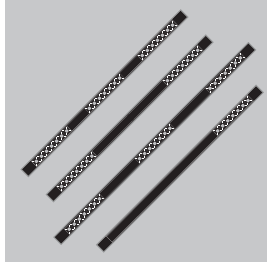

**PV - Contact Sales**  
Multiple baffle segments



**PV - Contact Sales**  
Direct / Indirect



**PV - Contact Sales**  
High colour rendering



**PV - Contact Sales**  
Asymmetric wall wash  
baffles



**PV - Contact Sales**  
Gloss black baffles



**PV - Contact Sales**  
Chrome effect baffles



**PV - Contact Sales**  
Matt silver baffles

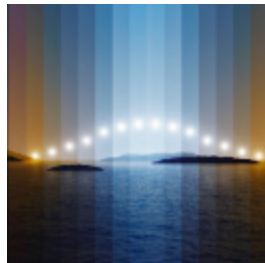

**PV - Contact Sales**  
Tunable white



**PV - Contact Sales**  
Choice of integral  
sensors

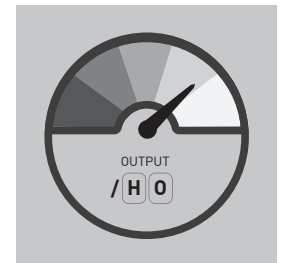

**PV - Contact Sales**  
Higher output

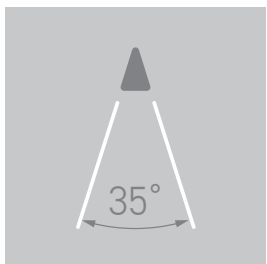

**PV - Contact Sales**  
Medium beam lenses  
35°

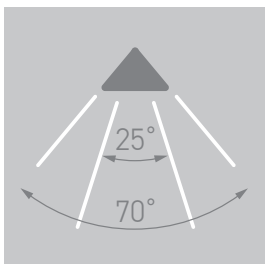

**PV - Contact Sales**  
Oval lenses 25-70°

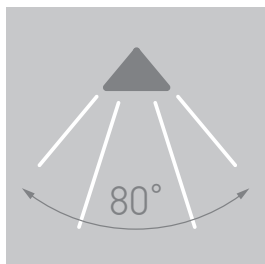

**PV - Contact Sales**  
Batwing lenses 80°