

# 129 Series

## Data Sheet



Made in the UK

LUMENLOOP

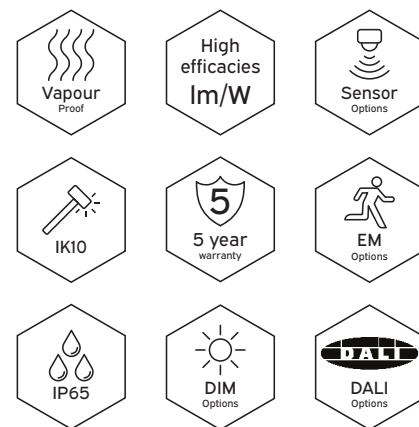

### KEY FEATURES

- IP65 anti-corrosive LED batten
- Robust IK10 rated injection-moulded polycarbonate body
- Clear vapour-proof IK10 rated high impact diffuser
- High system efficacy to aid Building Regulations Part L compliance
- Up to 158 luminaire lumens per total circuit Watt
- Nominal rated life >72,000h L80
- Tridonic LED and driver system
- Opal light pipe for homogenous output
- Quick-release flush mounted fixing clips
- Adjustable 1.5 m suspension kit and corner-mounting kit options
- Dimming, DALI, sensor control and emergency options

### DIMENSIONS

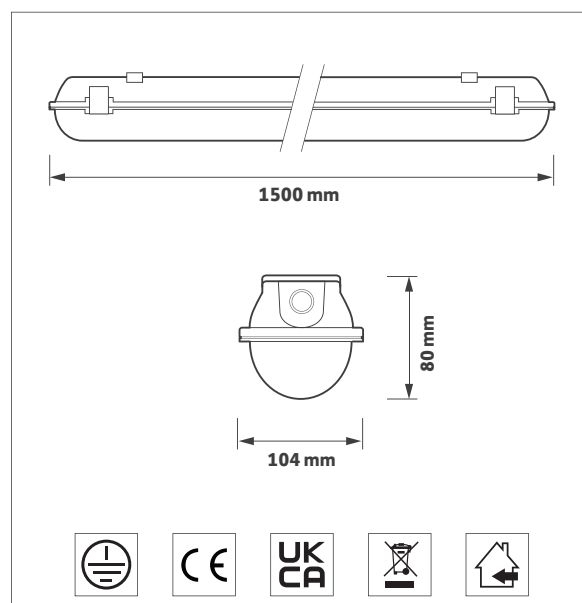

### ORDERING INFORMATION

Luminaire output (lm)	Colour temp	Luminaire power (tcW)	Light source efficacy (lm/W)	Luminaire efficacy (lm/tcW)	Model ref.
5250	830	36	177	146	<b>129.003</b>
5500	840	36	186	153	<b>129.004</b>
2800	830	18.5	194	151	<b>129.007</b>
2925	840	18.5	203	158	<b>129.008</b>

### OPTIONS

Options	Suffix
Control gear	<b>/ECO, /SO</b>
Emergency - Remote indicator	<b>/EM, /EMD</b>
Product variations available	<b>PV.</b>

# 129 Series

## Options and accessories

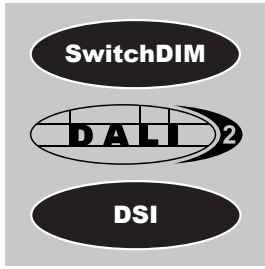

**/ECO**  
SwitchDIM, DALI & DSI



**/EM**  
Emergency



**/EMD**  
DALI emergency

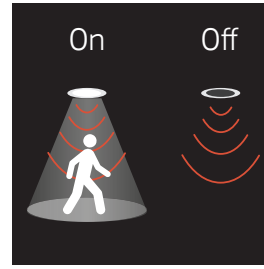

**/SO**  
Sensor on / off  
Not available with /ECO

### ACCESSORIES



**SUS129**  
1.5 m suspension kit

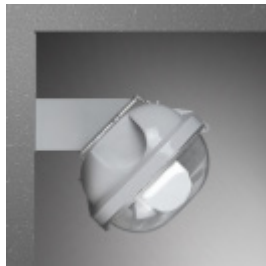

**CMK129**  
Corner mounting kit



**SC129/14**  
Stainless steel clips  
14 pack

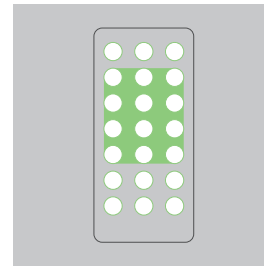

**SPR129**  
Sensor programming  
remote

### PV - PRODUCT VARIATIONS

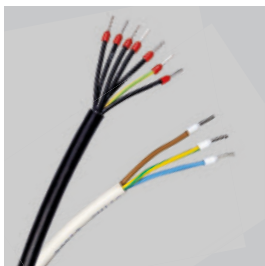

**PV - Contact Sales**  
LSOH / LSF cable



**PV - Contact Sales**  
Finish options



**PV - Contact Sales**  
Sensor options



**PV - Contact Sales**  
Casambi wireless  
network inc. dimming

### /SO SENSOR DETECTION RANGE

