

EMERGENCY BULKHEAD / IP65 / MAINTAINED OPERATION





Bright Emergency Bulkhead

IP65 maintained LED emergency bulkhead supplied with ISO legend kit options.

Bright Emergency Bulkhead is a maintained LED emergency bulkhead for commercial emergency lighting schedules requiring IP65 protection and clear fresnel lens construction.

The range includes a 150 llm, 3 W emergency bulkhead with a 3 hour battery duration, DALI / self-test option and adhesive ISO legend kit option.



 <p>IP65 rated IP65 rated maintained emergency bulkhead.</p>	 <p>3 hour duration The range includes a 3 hour NiCd battery duration.</p>	 <p>EN60598.2.22 Compliant with EN60598.2.22.</p>	 <p>DALI / self-test DALI and self-test option available.</p>
--	--	---	---

Key Features

- + IP65 rated LED maintained emergency bulkhead
- + Compliant with EN60598.2.22
- + 1 x 3.6V 1.5Ah NiCd battery - 3 hours duration
- + White polycarbonate base and clear fresnel lens

Technical Drawing

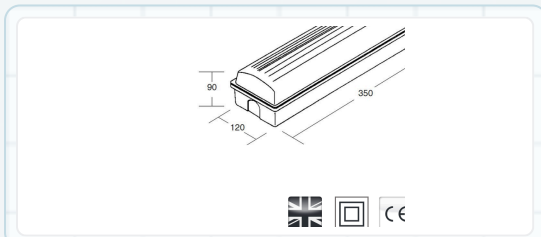







Length 350 mm	Width 120 mm
Height 90 mm	

Ordering Information

LUMINAIRE OUTPUT	POWER	COLOUR	MODEL REF.
150 llm	3 W	4 - 5000 K	BRIGHTEMERGENCYBULKHEAD.001

Options

/END DALI / Self-test	/ISO Adhesive legend kit (left-right-up)
--------------------------	---

						Declaration of Conformity available
---	---	---	---	---	---	-------------------------------------

Please note: Specification values may change due to rapid development of lighting technology. All performance data is taken at an ambient temperature of +25 deg C. Data may be rounded up/down for illustrative purposes. Tolerance range of optical and electrical data is +/-10%. We reserve the right to amend or change details without prior notification. E5DE.